

Data sheet | Item number: 2604-3312

PCB terminal block; lever; 4 mm<sup>2</sup>; Pin spacing 7.5 mm; 12-pole; Push-in  
CAGE CLAMP®



2604-3312



RoHS  Compliant

BOMcheck.net

Color: ■

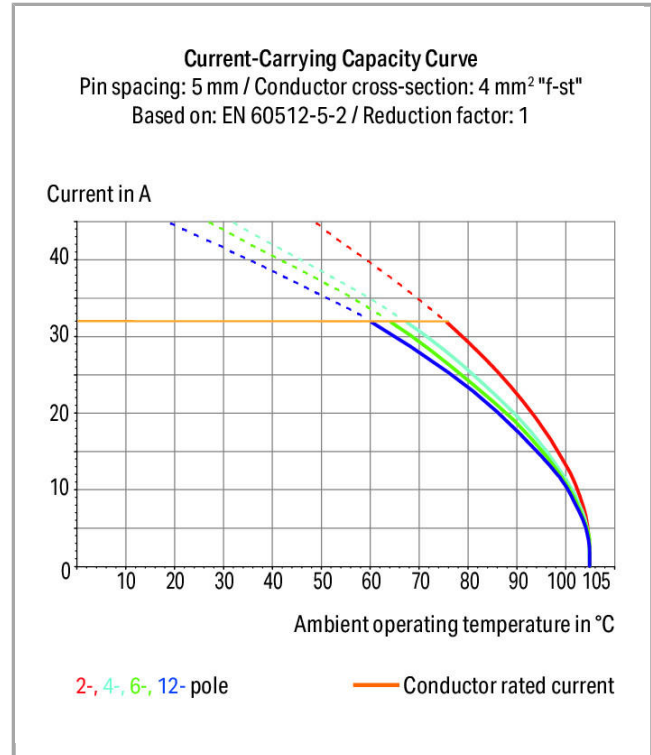

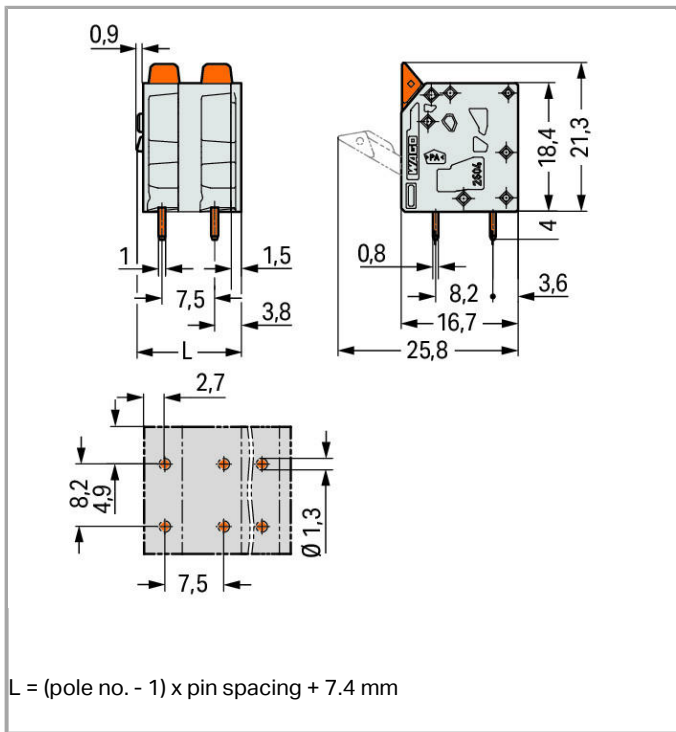

### Item description

- PCB terminal blocks with lever-actuated Push-in CAGE CLAMP® connection
- Push-in termination of solid and ferruled conductors
- Intuitive and tool-free operation
- Several clamping units can be held open simultaneously – convenient for terminating multi-core cables
- Testing can be performed both parallel and perpendicular to conductor entry

### Data

#### Electrical data

#### Ratings per IEC/EN 60664-1

Rated voltage (III / 3)	630 V
Rated impulse voltage (III / 3)	6 kV
Rated voltage (III / 2)	630 V
Rated impulse voltage (III / 2)	6 kV
Rated voltage (II / 2)	1000 V
Rated impulse voltage (II / 2)	6 kV
Rated current	32 A

#### Approvals per UL 1059

Rated voltage UL (Use Group B)	300 V
--------------------------------	-------



Rated current UL (Use Group B)	20 A
Rated voltage UL (Use Group C)	300 V
Rated current UL (Use Group C)	20 A
Rated voltage UL (Use Group D)	600 V
Rated current UL (Use Group D)	5 A

### Connection data

Connection technology	Push-in CAGE CLAMP®
Actuation type	Lever
Solid conductor	0.2 ... 4 mm <sup>2</sup> / 24 ... 12 AWG
Fine-stranded conductor	0.2 ... 4 mm <sup>2</sup> / 24 ... 12 AWG
Fine-stranded conductor with ferrule with plastic collar	0.25 ... 2.5 mm <sup>2</sup>
Fine-stranded conductor with ferrule without plastic collar	0.25 ... 2.5 mm <sup>2</sup>
Fine-stranded conductor, with twin ferrule	0.25 ... 1.5 mm <sup>2</sup>
Strip length	9 ... 11 mm / 0.35 ... 0.43 inch
Conductor entry angle to the PCB	90°
No. of poles	12
Total number of connection points	12
Total number of potentials	12
Number of connection types	1
Number of levels	1

### Geometrical Data

Pin spacing	7.5 mm / 0.295 inch
Width	89.9 mm / 3.539 inch
Height	25.3 mm / 0.996 inch
Height from the surface	21.3 mm / 0.839 inch
Depth	16.7 mm / 0.657 inch
Solder pin length	4 mm
Solder pin dimensions	0.8 x 1 mm
Drilled hole diameter (tolerance)	1.3 <sup>(-...+0.1)</sup> mm

### PCB contact

PCB contact	THT
Solder pin arrangement	over the entire terminal strip, in line
Number of solder pins per potential	2

### Material Data

Color	gray
-------	------

Material group	I
Insulating material	Polyamide 66 (PA 66)
Flammability class per UL94	V0
Clamping spring material	Chrome nickel spring steel (CrNi)
Contact material	Electrolytic copper (E <sub>Cu</sub> )
Contact plating	tin-plated
Fire load	0 MJ
Actuating element color	orange
Weight	24.21 g

### Environmental Requirements



Limit temperature range	-60 ... +105 °C
-------------------------	-----------------

### Commercial data

Country of origin	DE
GTIN	4055143564977
Customs Tariff No.	85369010000

### Approvals / Certificates

#### Country specific Approvals







Logo	Approval	Additional Approval Text	Certificate name
	<b>CB</b> DEKRA Certification B.V.	EN 60947-7-4	NL-47057
	<b>CSA</b> DEKRA Certification B.V.	C22.2 No. 158	70117145
	<b>KEMA/KEUR</b> DEKRA Certification B.V.	EN 60947-7-4	71-100535

#### UL-Approvals

Logo	Approval	Additional Approval Text	Certificate name
	<b>cULus</b> Underwriters Laboratories Inc.	UL 1059	E45172 sec. 71

## Compatible products

## ferrule

	<b>Item no.: 216-106</b> Ferrule; Sleeve for 2.5 mm <sup>2</sup> / AWG 14; uninsulated; electro-tin plated	216-106
	<b>Item no.: 216-241</b> Ferrule; Sleeve for 0.5 mm <sup>2</sup> / 20 AWG; insulated; electro-tin plated; electrolytic copper; gastight crimped; acc. to DIN 46228, Part 4/09.90	216-241
	<b>Item no.: 216-242</b> Ferrule; Sleeve for 0.75 mm <sup>2</sup> / 18 AWG; insulated; electro-tin plated; electrolytic copper; gastight crimped; acc. to DIN 46228, Part 4/09.90	216-242
	<b>Item no.: 216-243</b> Ferrule; Sleeve for 1 mm <sup>2</sup> / AWG 18; insulated; electro-tin plated; electrolytic copper; gastight crimped; acc. to DIN 46228, Part 4/09.90	216-243
	<b>Item no.: 216-244</b> Ferrule; Sleeve for 1.5 mm <sup>2</sup> / AWG 16; insulated; electro-tin plated; electrolytic copper; gastight crimped; acc. to DIN 46228, Part 4/09.90	216-244
	<b>Item no.: 216-246</b> Ferrule; Sleeve for 2.5 mm <sup>2</sup> / AWG 14; insulated; electro-tin plated; electrolytic copper; gastight crimped; acc. to DIN 46228, Part 4/09.90	216-246

## Downloads

## Documentation

## Additional Information

pdf  
3.6 MB

Download

## CAD/CAE - Smart Data

## CAD data

3D Download 2604-3312

URL

Download

Subject to changes.